

REL-MR-BL- 24DC/21-21 - Single relay



2906286

<https://www.phoenixcontact.com/us/products/2906286>

Please be informed that the data shown in this PDF document is generated from our online catalog. Please find the complete data in the user documentation. Our general terms of use for downloads are valid.

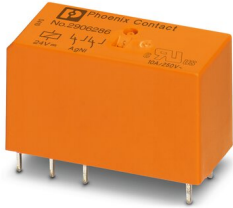

Plug-in miniature power relay in basic design, with power contact, 2 changeover contacts, input voltage 24 V DC

Commercial data

Item number	2906286
Packing unit	1 pc
Minimum order quantity	20 pc
Sales key	C460
Product key	CK6195
GTIN	4055626066936
Weight per piece (including packing)	13 g
Weight per piece (excluding packing)	14.4 g
Customs tariff number	85364900
Country of origin	AT

Technical data

Product properties

Product type	Single relay
Operating mode	100% operating factor
Mechanical service life	3x 10 ⁷ cycles

Insulation characteristics

Insulation	Basic insulation
------------	------------------

Insulation characteristics

Insulation	Basic insulation
Overvoltage category	III
Pollution degree	3

Electrical properties

Service life electrical	see diagram
Maximum power dissipation for nominal condition	0.4 W
Test voltage (Winding/contact)	5 kV AC (50 Hz, 1 min., winding/contact)
Rated insulation voltage	250 V AC
Rated surge voltage	4 kV

Input data

Coil side

Nominal input voltage U_N	24 V DC
Input voltage range	16.8 V DC ... 54 V DC
Drive and function	monostable
Drive (polarity)	non-polarized
Typical input current at U_N	17 mA
Typical response time	8 ms
Typical release time	6 ms

Output data

Switching

Contact switching type	2 changeover contacts
Type of switch contact	Single contact
Contact material	AgNi
Maximum switching voltage	250 V AC/DC
Minimum switching voltage	5 V (at 10 mA)
Limiting continuous current	8 A
Maximum inrush current	12 A (20 ms)
Min. switching current	10 mA (At 5 V)
	190 W (at 24 V DC)

REL-MR-BL- 24DC/21-21 - Single relay



2906286

<https://www.phoenixcontact.com/us/products/2906286>

Interrupting rating (ohmic load) max.	85 W (at 48 V DC)
	60 W (at 60 V DC)
	44 W (at 110 V DC)
	60 W (at 220 V DC)
	2000 VA (for 250 V AC)
Switching capacity	2 A (at 24 V, DC13)
	1.5 A (at 230 V, AC15)

Connection data

Connection method	Solder connection
-------------------	-------------------

Dimensions

Dimensional drawing	
Width	12.7 mm
Height	29 mm
Depth	15.7 mm

Environmental and real-life conditions

Ambient conditions

Degree of protection	RT II
Ambient temperature (operation)	-40 °C ... 85 °C
Ambient temperature (storage/transport)	-40 °C ... 85 °C

Standards and regulations

Standards/regulations	IEC 60664
	EN 61810-1

Mounting

Mounting type	Plug-in mounting
Mounting position	any

Drawings

Diagram

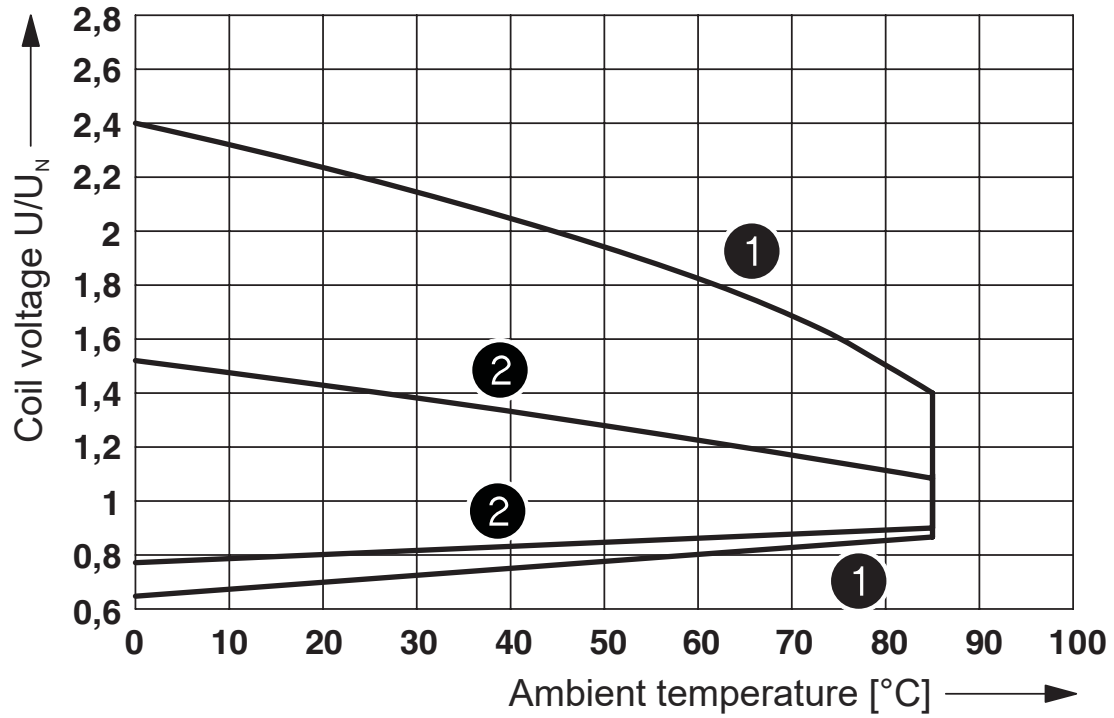

- ① DC coils
- ② AC coils

Operating voltage range

Diagram

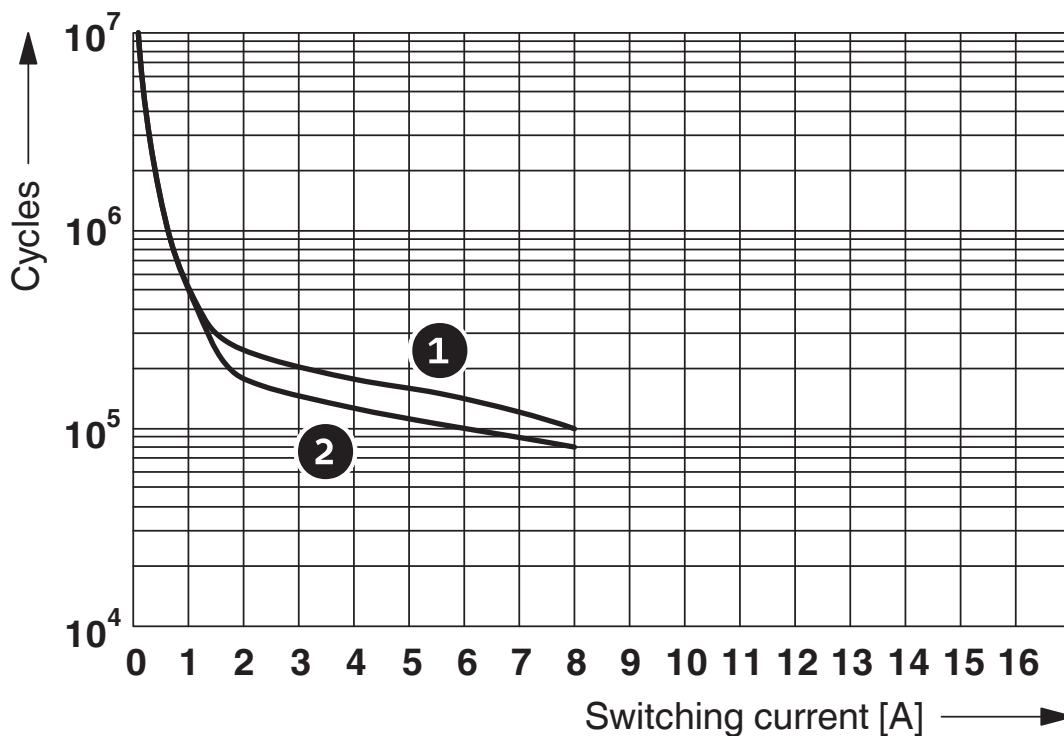

- ① 250 V AC, ohmic load (DC coils)
- ② 250 V AC, ohmic load (AC coils)

Electrical service life

Circuit diagram

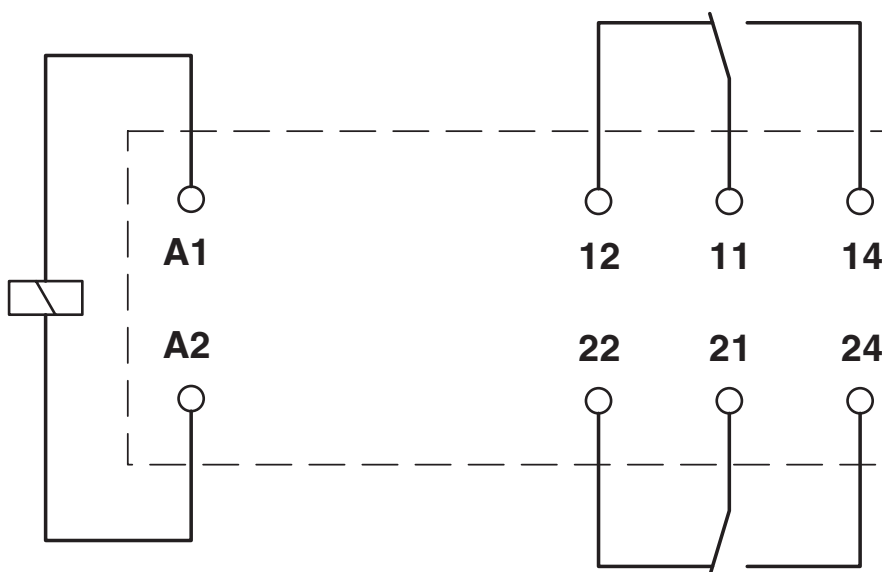

Diagram

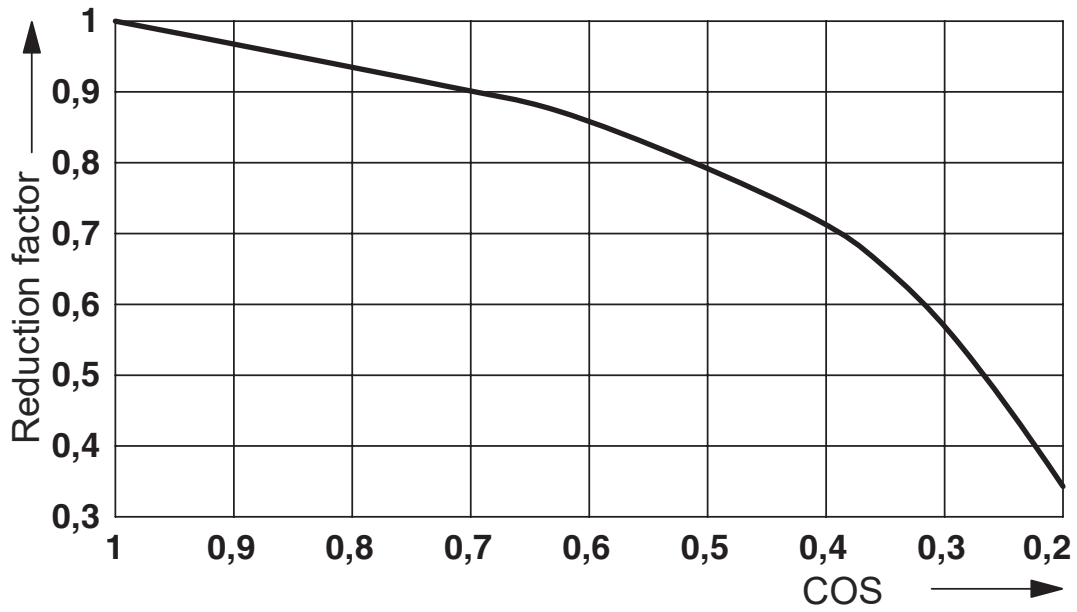

Service life reduction factor with various cos phi

Drilling plan/solder pad geometry

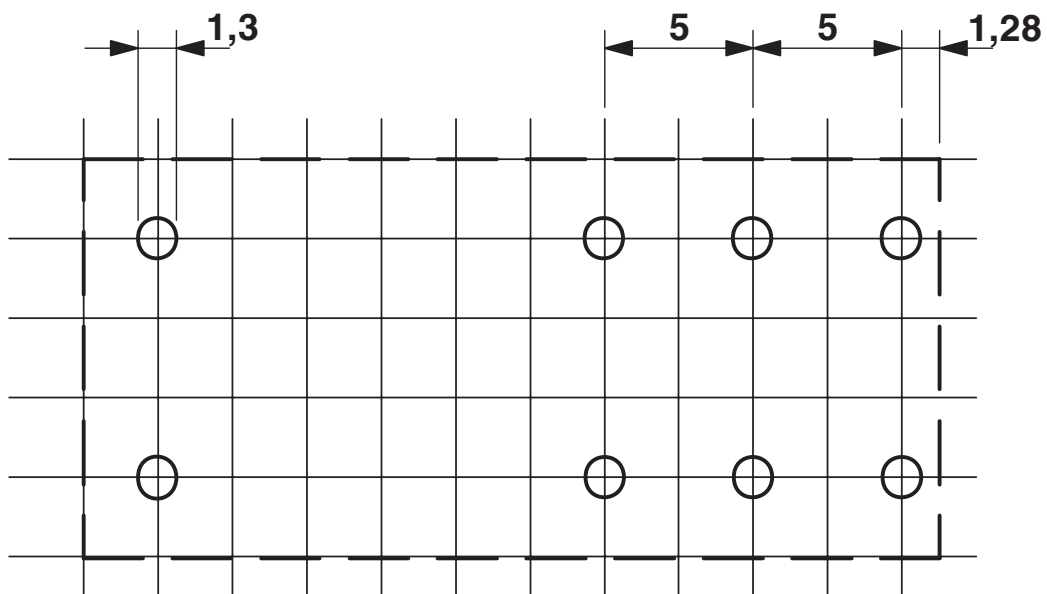

Basic pitch 2.5 mm

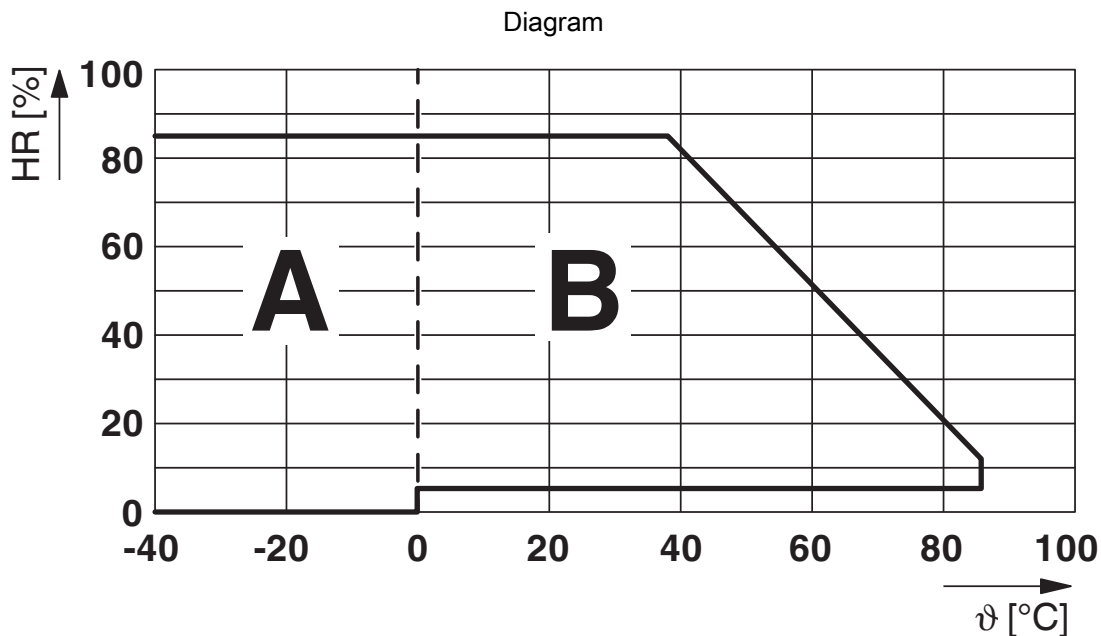

Permissible humidity for operation and storage.

The maximum permissible ambient temperature as specified in the data sheet must be observed.

Area A: Ice buildup at ambient temperatures $\leq 0^\circ\text{C}$ must be prevented

Area B: Condensation at ambient temperatures $> 0^\circ\text{C}$ must be prevented

On 30 full days that are naturally distributed across an entire year, a humidity level of 95% is permissible at an ambient temperature $\leq 25^\circ\text{C}$.

Dimensional drawing

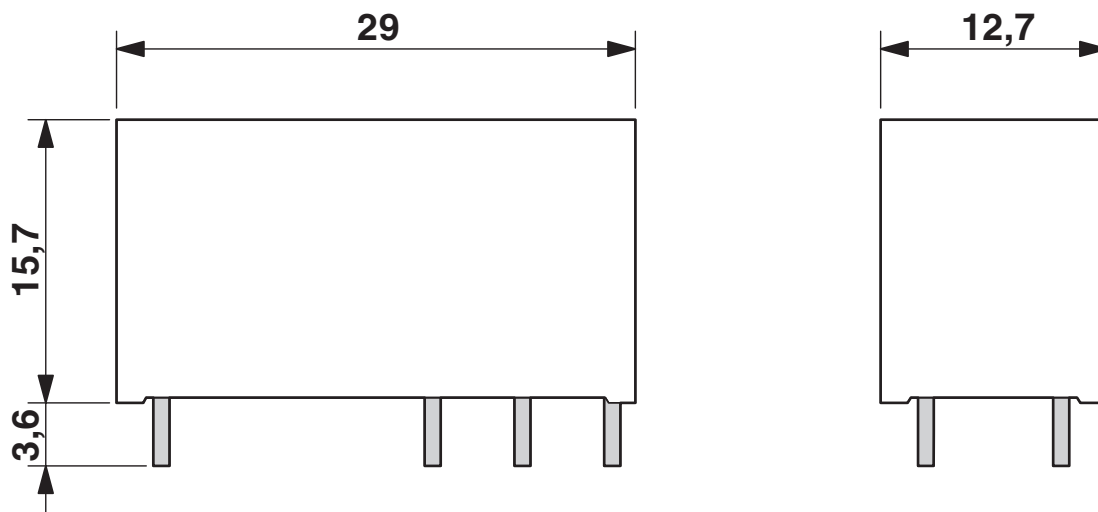

REL-MR-BL- 24DC/21-21 - Single relay



2906286

<https://www.phoenixcontact.com/us/products/2906286>

Approvals

To download certificates, visit the product detail page: <https://www.phoenixcontact.com/us/products/2906286>



cUL Recognized

Approval ID: FILE E 228652



UL Recognized

Approval ID: FILE E 228652



EAC

Approval ID: TR_TS_D_00573_c

cULus Recognized

REL-MR-BL- 24DC/21-21 - Single relay



2906286

<https://www.phoenixcontact.com/us/products/2906286>

Classifications

ECLASS

ECLASS-11.0	27371601
ECLASS-12.0	27371601
ECLASS-13.0	27371601

ETIM

ETIM 8.0	EC001437
----------	----------

UNSPSC

UNSPSC 21.0	39122300
-------------	----------

REL-MR-BL- 24DC/21-21 - Single relay



2906286

<https://www.phoenixcontact.com/us/products/2906286>

Environmental product compliance

China RoHS	Environmentally friendly use period: unlimited = EFUP-e
	No hazardous substances above threshold values

REL-MR-BL- 24DC/21-21 - Single relay



2906286

<https://www.phoenixcontact.com/us/products/2906286>

Accessories

ECOR-1-BSC2-RT/2X21 - Relay base

1027546

<https://www.phoenixcontact.com/us/products/1027546>

ECOR-1... relay base, for miniature power relays or miniature switching relays with 1 or 2 changeover contacts, bolt connection, for mounting on NS 35/7,5.

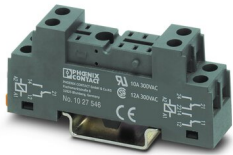

ECOR-1-BSC3/2X21 - Relay base

2907518

<https://www.phoenixcontact.com/us/products/2907518>

ECOR-1... relay base, for miniature power relay or miniature switching relay with 1 or 2 changeover contacts, screw connection, plug-in option for input/interference suppression modules, for mounting on NS 35/7,5



Phoenix Contact 2023 © - all rights reserved

<https://www.phoenixcontact.com>

Phoenix Contact USA
586 Fulling Mill Road
Middletown, PA 17057, United States
(+717) 944-1300
info@phoenixcon.com